

15BX

15-Inch Long-Throw Bass Guitar Loudspeaker

- Contoured response for bass guitar
- Improved low-frequency performance—less distortion at low frequencies
- Ideal upgrade speaker
- 400 watts long-term power capacity
- Edge-wound flat aluminum wire for maximum output and “bullet-proof” reliability
- 102-dB sensitivity

SPECIFICATIONS

Usable Frequency Response in a Typical Vented 4.5-Cubic-Foot Enclosure

(1 watt/1 meter; see Figure 1):

30-4,000 Hz

Sound Pressure Level (1 watt/1 meter):

102 dB

Long-Term Average Power Handling Capacity (per EIA RS-426-A 1980; see

Power Handling section):

400 watts

Nominal Impedance:

8 ohms

Voice-Coil Diameter:

63.5 mm (2.5 in.)

Thiele-Small Driver Parameters

f_s (free-air resonance frequency):

40 Hz

Q_{ES} (electromagnetic Q at f_s):

0.27

Q_{MS} (mechanical Q at f_s):

8.93

Q_{TS} (total Q at f_s): $\frac{(Q_{ES} Q_{MS})}{(Q_{ES} + Q_{MS})}$:

0.26

V_{AS} (volume of air having same acoustic compliance as driver suspension):

229.4 liters (8.1 ft³)

η_0 (half-space reference efficiency):

5.3%

V_D (peak displacement volume of

diaphragm: $S_D \times X_{max}$):

0.349 liters (0.0122 ft³)

S_D (effective diaphragm area):

0.086 m² (132.6 in.²)

X_{max} (peak linear displacement of

diaphragm):

4.06 mm (0.16 in.)

R_e (dc resistance of voice coil):

6.0 ohms $\pm 10\%$

Mounting Information

(see Installation section),

Mounting Hole Diameter

(eight evenly spaced holes):

7.1 mm (0.28 in.)—letter “L” drill

Bolt Circle Diameter:

370 mm (14.56 in.)

Baffle Opening Diameter

(front or rear mounting):

353 mm (13.88 in.)

Optional Mounting Accessory:

SMH-1 mounting hardware kit

Dimensions (see Figure 2),

Overall Diameter:

384 mm (15.13 in.)

Overall Depth:

178 mm (7.0 in.)

Net Weight:

9.1 kg (20 lb)

Shipping Weight:

11.4 kg (25 lb)

DESCRIPTION

The Electro-Voice 15BX is a 15-inch speaker designed for professional, high-level, high-quality musical instrument systems. Used full range, the 15BX's frequency response is specifically tailored for a traditional bass guitar sound. The 15BX incorporates voice-coil and suspension refinements, including beryllium copper flatwire leads, that have improved performance. Power capacity is 400 watts per EIA RS-426-A 1980. The Power-Handling section describes these ratings in detail.

The construction of the 15BX features an overhanging low-mass edge-wound voice coil on a rugged laminated polyimide coil form, driven by our large, 16-lb magnetic structure. Also featured are a heavy-duty curvilinear cone and a fatigue-resistant cone suspension. Both the coil and magnetic structure are vented. All of this is

packaged around a robust, eight-spoke, diecast aluminum frame.

The 15BX may be front- or rear-mounted without an adapter. The optional SMH-1 speaker mounting kit facilitates front mounting (see Installation section).

RECOMMENDED ENCLOSURES

Replacement Use in Existing Enclosures

The 15BX will often be used to replace inferior speakers in existing enclosures. Mechanical and electrical characteristics are such that the superior efficiency, sound quality and reliability of the 15BX will be realized in virtually any sealed, vented (bass reflex) or horn-loaded enclosure.

Vented Enclosures

The most extended, lowest distortion and best-controlled bass performance is usually realized in properly designed vented enclosures. In such designs, the vent, or port, actually reproduces the lowest octave or so of bass response. The vent is driven to full acoustic output by a relatively small motion of the speaker cone itself, acting through the air contained within the enclosure. The excursion of the 15BX at these frequencies is much reduced compared to sealed or open-back enclosures, directly reducing harmonic distortion.

Often, in bass guitar systems, a perfectly flat response is not as important as a controlled response. Typical sound-reinforcement systems are “tuned,” so the enclosure provides the flattest possible response. Generally, bass-guitar system performance is improved if the enclosure is vented or tuned for roughly the lowest notes that will be played through it. For standard tuning four-string bass, a 44 Hz tuning is recommended. The low “E” on a bass guitar actually vibrates at 41.2 Hz, but a 44 Hz tuning will

15BX SPECIFICATION GRAPHICS

FIGURE 1 — 15BX Frequency Response in Typical Enclosure (4.5 ft³), 1 Watt/1 Meter

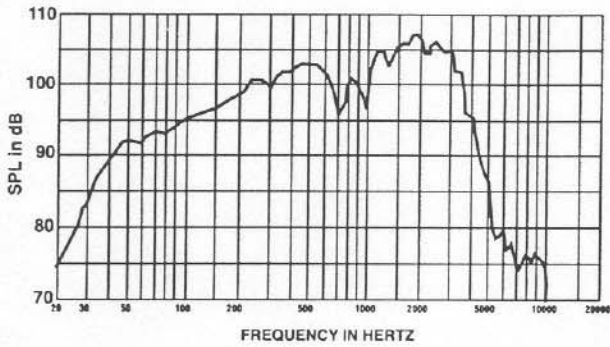

FIGURE 5 — Fillister and Internal Hex Drive Screws for Front Mounting (not to scale)

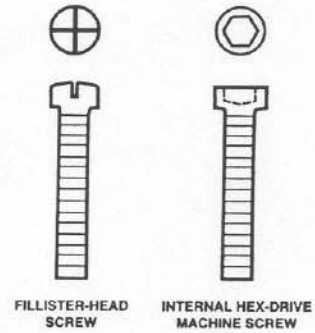

FIGURE 2 — 15BX Dimensions

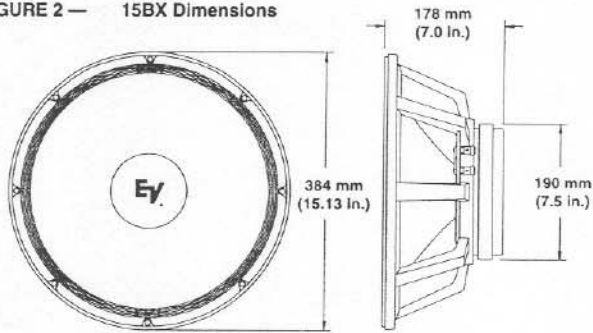

FIGURE 6 — Connection of Two 15BX Speakers in Parallel (net impedance is 4 ohms)

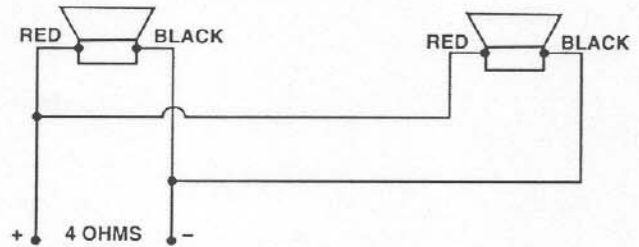

FIGURE 3 — Front-Mounting Detail (not to scale)

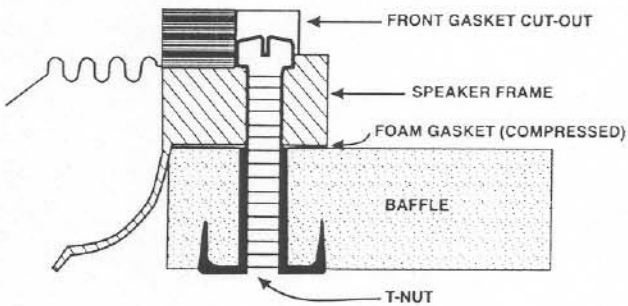

FIGURE 7 — Connection of Two 15BX Speakers in Series (net impedance is 16 ohms)

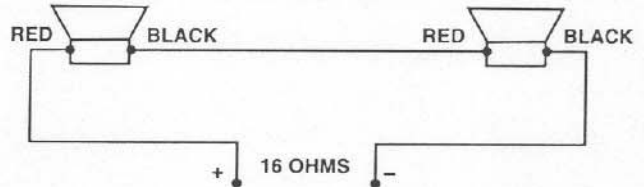

FIGURE 4 — Rear-Mounting Detail (not to scale)

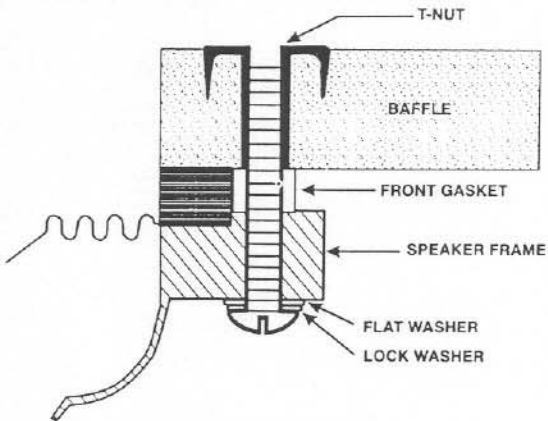
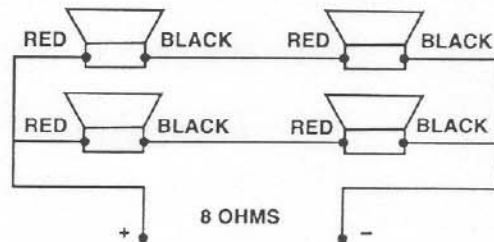

FIGURE 8 — Connection of Four 15BX Speakers in Series/Parallel (net impedance is 8 ohms)



provide a reasonable amount of vent contribution or additional output at 41.2 Hz. Similarly, an enclosure tuning of 34 Hz is recommended for a system that will reproduce standard five- or six-string signals. If a four-string bass with a "dropped-D" is used, the recommended tuning frequency is 40 Hz. For any of the above examples, the recommended enclosure internal volume is between three and five cubic feet. The larger the volume, the less equalization will be required. An enclosure volume of four-and-one-half cubic feet is ample for most situations.

INSTALLATION

The 15BX may be front- or rear-mounted, although front mounting is preferred because of convenience. For simple front mounting, the convenient SMH-1 mounting accessory is recommended. Complete mounting instructions for standard front mounting are given below. It is important that recommended baffle openings and mounting hole locations be followed.

Front Mounting

Front mounting requires a 353-mm (13.88-in.) diameter cutout and a 370-mm (14.56-in.) bolt circle. Mark the baffle opening and screw locations on the blank panel first. Drill the screw holes before cutting the large baffle opening. If 1/4-20 screws are used, four screws are sufficient for secure mounting of the speaker. T-nuts are recommended for simple, secure mounting. If T-nuts are used, the holes should be 7.1-mm (0.281-in.) diameter (letter "L" drill). Apply glue to the flanges of 1/4-20 long shank T-nuts before driving into the rear of the holes.

Sealing of the front-mounted speaker is accomplished with the adhesive-backed foam gasket segments that are included with your new 15BX. Strip off the protective paper and apply the gasket to the rear mounting surface of the speaker rim, making certain that the holes in the gasket line up with the mounting holes in the speaker frame.

Length of the 1/4-20 screws should be 1/2-inch plus the panel thickness when using T-nuts. The screws must be fillister head or internal hex drive machine screws to seat down in the recess of the speaker frame gasket (see Figure 3). Screws should be tightened evenly and securely. Maximum torque possible with a proper size screwdriver should be sufficient.

IMPORTANT! When front mounting, the screw head must fit down into the front gasket cutout (see Figure 3).

Rear Mounting

Rear mounting requires the same diameter cutout and screw circle as front mounting. Other comments regarding the use of T-nuts apply to rear mounting as well.

Screw length should be 3/4-inch plus panel thickness if using T-nuts—longer for standard hex nuts. If hex nuts are used, a second nut should be tightened against the first nut to prevent loosening during operation. A lock washer and flat washer are recommended between the screw head and frame (see Figure 4).

Screws should be tightened evenly, but not excessively. Maximum torque possible with a proper size screwdriver should be sufficient. Do not use adhesive-back gasket segments for rear mounting.

Custom Enclosures

If a cabinet is to be constructed from scratch, 3/4-inch solid and jointed or marine plywood is recommended. After construction, be certain interior is completely free of metal filings, wood chips, etc.

Electrical Connections

Use no. 18 or larger stranded wire to connect the two terminals on the loudspeaker to the amplifier output.

FREQUENCY RESPONSE

Frequency response was measured with the 15BX in a 4.5-cubic-foot vented enclosure, tuned to 40 Hz, placed in an anechoic (echoless) environment at 1 meter on axis with a 1-watt swept sine-wave input. The frequency-response curve is shown in Figure 1.

POWER-HANDLING

In musical-instrument systems, unlike sound-reinforcement systems, it is advisable to use speakers that are rated for at least as much power as your amplifier output rating.

To our knowledge, Electro-Voice was the first U.S. manufacturer to develop and publish a power test closely related to real-life conditions. Specifically, the 15BX is designed to withstand the power test described in EIA RS-426-A 1980. The EIA test spectrum is applied for eight hours. This shaped signal is sent to a power amplifier with the continuous power set at 400 watts into the 6.9 ohms EIA equivalent impedance (52.5 volts true rms). Amplifier clipping sets instantaneous peaks at 6 dB above the continuous power, or 1,600 watts peak (105.1 volts peak). This procedure provides a rigorous test of both thermal and mechanical failure modes.

UNIFORM LIMITED WARRANTY

Electro-Voice products are guaranteed against malfunction due to defects in materials or workmanship for a specified period, as noted in the individual product-line statement(s) below, or in the individual product data sheet or owner's manual, beginning with the date of original purchase. If such malfunction occurs during the

specified period, the product will be repaired or replaced (at our option) without charge. The product will be returned to the customer prepaid. Exclusions and Limitations: The Limited Warranty does not apply to: (a) exterior finish or appearance; (b) certain specific items described in the individual product-line statement(s) below, or in the individual product data sheet or owner's manual; (c) malfunction resulting from use or operation of the product other than as specified in the product data sheet or owner's manual; (d) malfunction resulting from misuse or abuse of the product; or (e) malfunction occurring at any time after repairs have been made to the product by anyone other than Electro-Voice or any of its authorized service representatives. **Obtaining Warranty Service:** To obtain warranty service, a customer must deliver the product, prepaid, to Electro-Voice or any of its authorized service representatives together with proof of purchase of the product in the form of a bill of sale or receipted invoice. A list of authorized service representatives is available from Electro-Voice at 600 Cecil Street, Buchanan, MI 49107 (616/695-6831 or 800/234-6831). **Incidental and Consequential Damages Excluded:** Product repair or replacement and return to the customer are the only remedies provided to the customer. Electro-Voice shall not be liable for any incidental or consequential damages including, without limitation, injury to persons or property or loss of use. Some states do not allow the exclusion or limitation of incidental or consequential damages so the above limitation or exclusion may not apply to you. **Other Rights:** This warranty gives you specific legal rights, and you may also have other rights which vary from state to state.

Electro-Voice Speakers and Speaker Systems are guaranteed against malfunction due to defects in materials or workmanship for a period of five (5) years from the date of original purchase. The Limited Warranty does not apply to burned voice coils or malfunctions such as cone and/or coil damage resulting from improperly designed enclosures. Electro-Voice active electronics associated with the speaker systems are guaranteed for three (3) years from the date of original purchase. Additional details are included in the Uniform Limited Warranty statement.

Service and repair address for this product: Electro-Voice, Inc., 600 Cecil Street, Buchanan, Michigan 49107 (616/695-6831 or 800/234-6831).

Specifications subject to change without notice.